



GstarCAD 2023

Remarkable Performance and Compatibility

What is GstarCAD

GstarCAD is well-known alternative CAD software of high compatibility with ACAD. With nearly 30 years of continuous improvement and lean innovation, today GstarCAD is far ahead in performance, stability and other key indicators and becomes leading CAD software in the world.

CATALOGUE

Profile 1

Advantages 2

Performance
Perfect Compatibility
Perfect Compatibility
Flexible Licensing

Improvement 3

Performance	VBA
ObjectARX API	Block Editor
REVCLOUD	PALETTES
CUI Editor	HELP
LOCKUP	Layout Expand Button
DWF Import	AI_EDITCUSTFILE

New Features 7

NAVICUBE	Lisp Debugger
Digital Signature	VPSYNC
SYSVARMONITOR	Reset Settings to Default
LAYOUTMERGE	CLIPIT
CLOSELINE	ATTIPEDIT

Innovative 11

SVG File

Profile

GstarCAD 2023

Remarkable Performance and Compatibility

GstarCAD 2023 is greatly optimized in performance by supporting Multi-Core and Parallel processing. The user experience and compatibility are also improved with many practical improvements and over 12 new features, such as supporting the NAVICUBE, Lisp Debugger, Digital Signature and VPSYNC, as well as compatibility with ObjectARX APIs, improving the display of Palettes, and providing two more valuable tools in the Block Editor, etc.

Advantages

Performance

Higher performance plays an important role in GstarCAD. The performance of common-use operations like "OPEN", "QSAVE", "PLOT", "CLIP", "TRIM", "PASTE", "MOVE", "DYNAMIC SELECTION", and more commands are significantly faster than other CAD software.



Perfect Compatibility

GstarCAD constantly improves its compatibility in all aspects and accomplishes the high compatibility with ACAD. The seamless data format, familiar interface, command structure and user operating habit, ease of use customization settings and applications/add-ons are all ready for you in GstarCAD 2023.



Innovative Tools

GstarCAD offers over 100 unique and innovative tools like "Collaboration", "Area Table", "Auto Layer", "Viewport to Layout", "Autolxstable". They are adopted to significantly speed up your drafting speed.



Flexible Licensing

GstarCAD licensing policy is flexible and simple. We provide both perpetual license and subscription. You are free to choose the license mode and you decide when to upgrade.

	Stand-alone	Stand-alone	Network	Network
	License-key Serial number	USB-key Dongle	License-key Serial number	USB-key Dongle
Perpetual license	✓	✓	✓	✓
Rental license	✓	✗	✓	✗
License borrowing	✗	✗	✓	✗
Connection to license server	✗	✗	✓	✓

Improvement

Performance

Multi-Core is supported in GstarCAD 2023, which makes the performance significantly optimized. The speed of opening drawings increases almost 100%, and the operation process is much smoother.

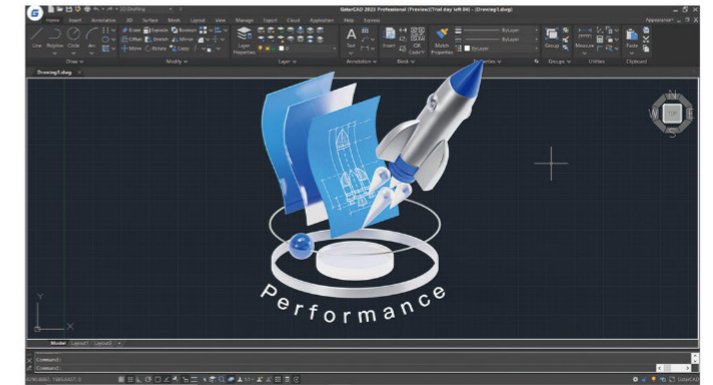

VBA

The 64Bit Visual Basic for Applications (VBA) has been supported in the GstarCAD 64bit Platform since GstarCAD 2023. You are able to access and use the VBA integrated development environment (VBAIDE) and work with the GstarCAD object model.

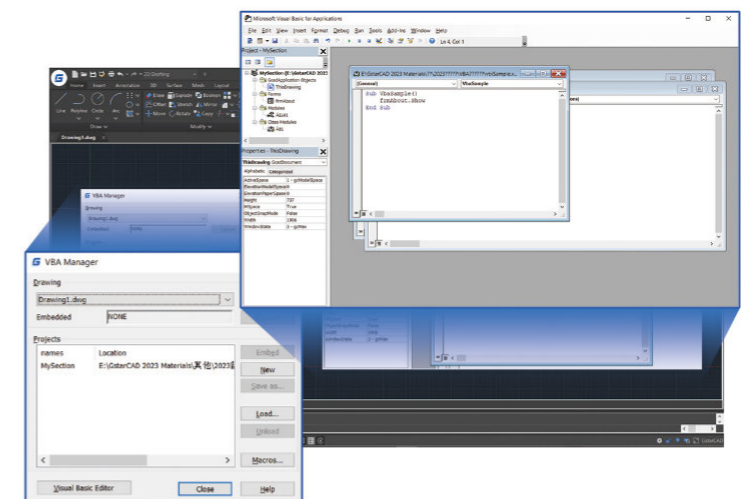

ObjectARX API

GstarCAD 2023 GRX is compatible with AutoCAD ObjectARX 2020 APIs, programs can be successfully compiled, loaded and used without editing code, which saves a lot of time in migrating applications developed with AutoCAD ObjectARX. Also, the APIs are not going to be changed in the next several years, so the applications only need to be migrated once.

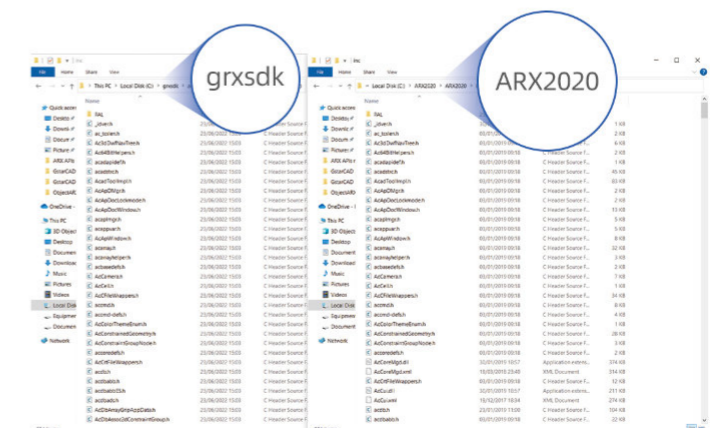

Block Editor

In GstarCAD 2023, BAUTHORPALETTE and BTABLE features are supported to enhance the compatibility of the block editor. Both of them are available only in the block editor.

■ BAUTHORPALETTE

The BAUTHORPALETTE command opens the Block Authoring Palettes window in the Block Editor, which we can use to add parameters and actions to your dynamic block definition. The Parameters tab, Actions tab and Parameter Sets tab are in the Block Authoring Palettes window by default.

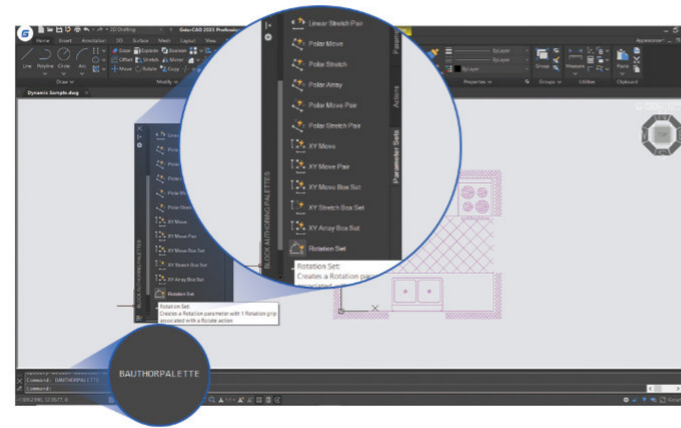

■ BTABLE

The BTABLE command stores variations of a dynamic block in the Block Properties Table that includes properties such as legacy parameters and user parameters. Each row in the table defines a different variation of the dynamic block.

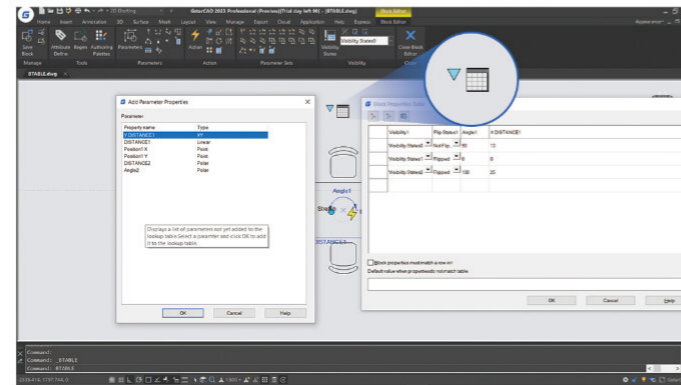

REVCLOUD

The "Rectangular", "Polygonal" and "Modify" options are added to the REVCLOUD command, and the number of grips displayed on a rectangular or polygonal revision cloud can be controlled. So, you can create a revision cloud or redefine an existing revision cloud more easily.

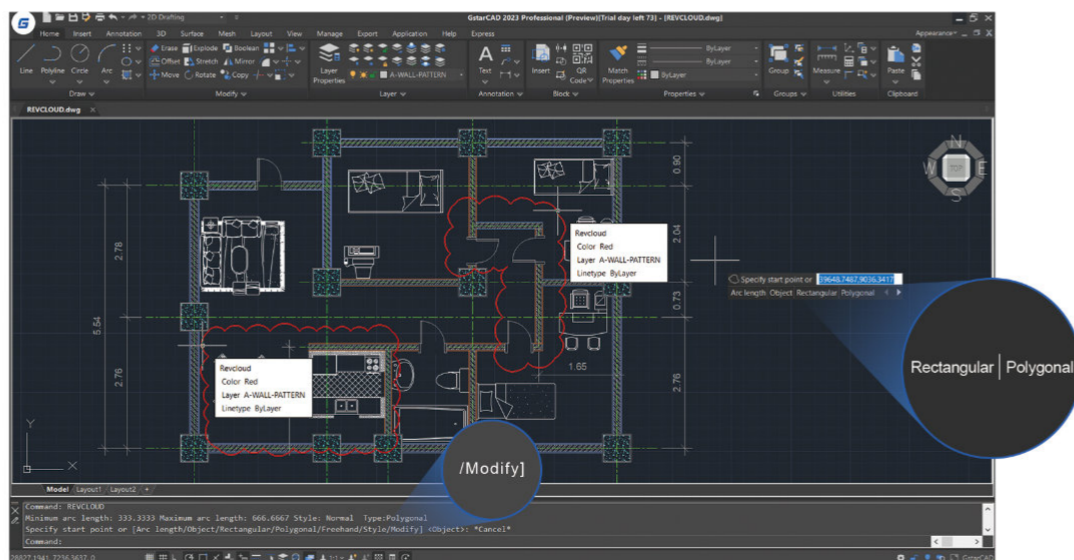

PALETTES

Floating palettes and windows in GstarCAD 2023 provide "Anchor left/right", "Auto-hide" and transparency adjustment options, as well as memorizing the locations and settings of floating palettes and windows.

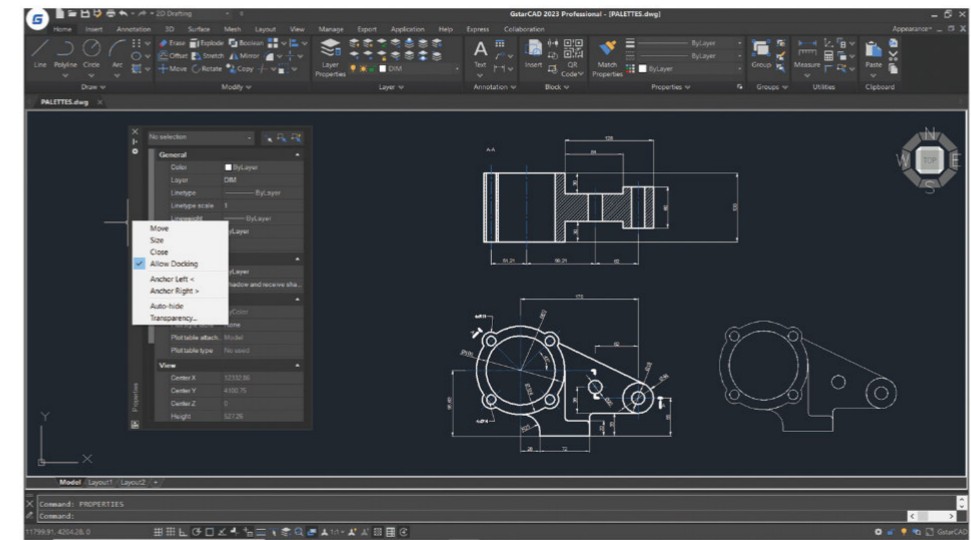

CUI Editor

"Ribbon Control Elements" and "Toolbar Control Elements" items are added to the categories drop-down list in the command list pane of the CUI editor, which you can select to filter and add elements quickly. Also, Layer State Gallery and LayerFilterCom-BoControl elements are added under Ribbon Control Elements category.

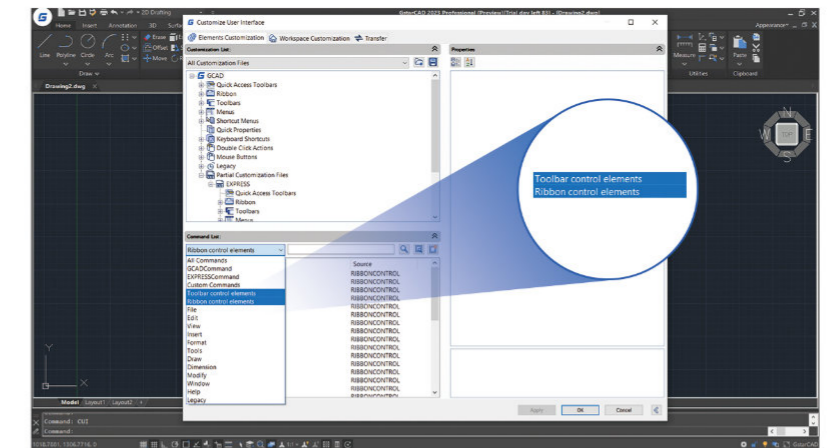

HELP

Online Help is supported in GstarCAD 2023, by default, the Online Help will be displayed in your default browser. It offers more frequently updated information, better search experience and guaranteed data security.

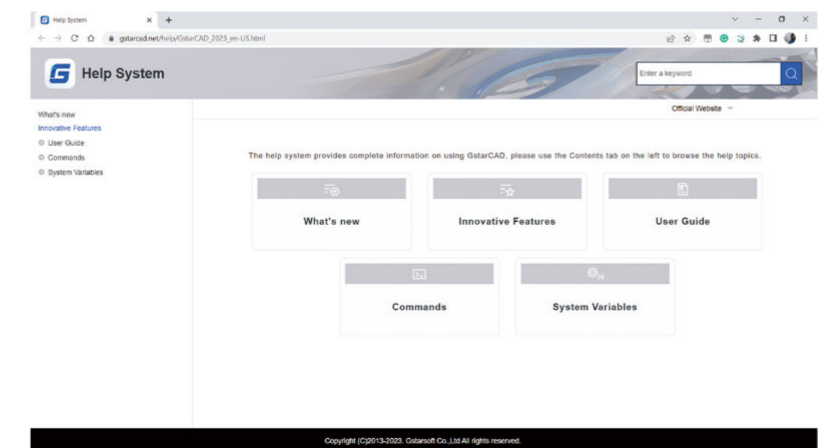

LOCKUP

The LOCKUP command supports locking selected objects in a drawing with a password to prevent them from being accidentally modified or deleted. You can execute the UNLOCK command and input the password to unlock them.

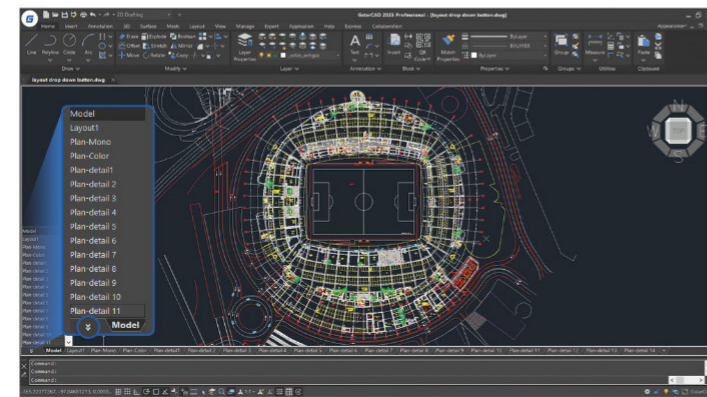
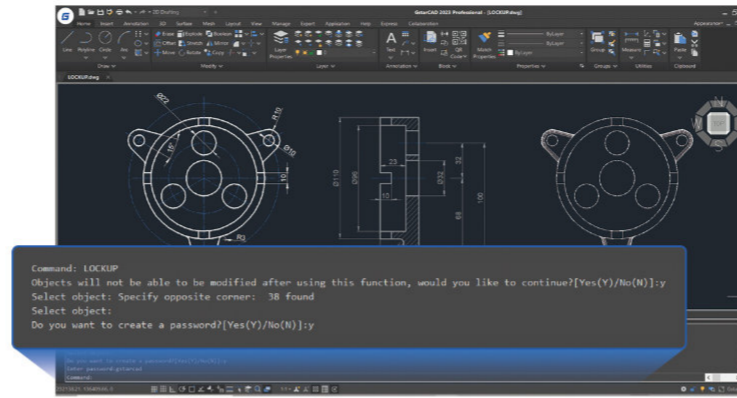

Layout Expand Button

The Layout Expand Button on the left side of the Layout Tabs can open a layout name list that allows jumping to any existing layout quickly when there are too many layouts in your drawing and some of them are not visible.

DWF Import

DWF files can be imported to GstarCAD 2023, and are available for editing after being exploded with EXPLODE or BURST command.

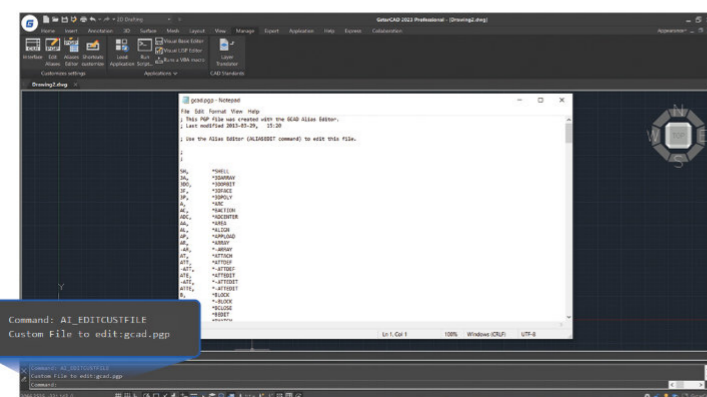
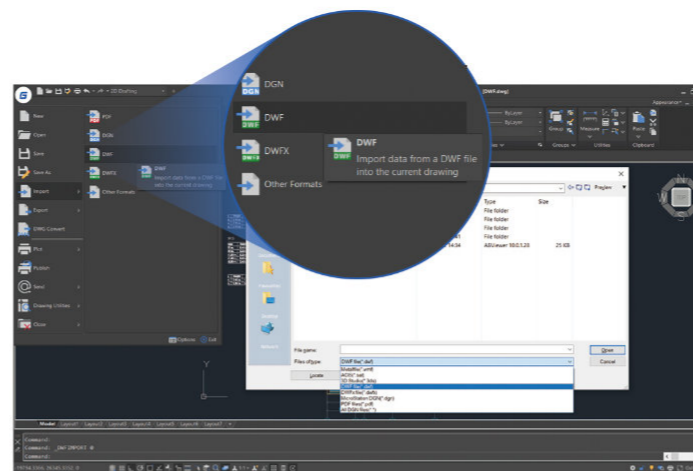

AI_EDITCUSTFILE

In GstarCAD 2023, the AI_EDITCUSTFILE command is supported to enhance the compatibility with AutoCAD, which opens the Program Parameters (PGP) text file where you can add or edit your command aliases.

New Features

NAVICUBE

A navigation tool is displayed in 2D or 3D model space, which allows switching between standard and isometric views more easily. It consists of a cube, compass and options, which is draggable and clickable, and supports switching to any available preset views, rolling the current view, or setting the current view as the Home view.

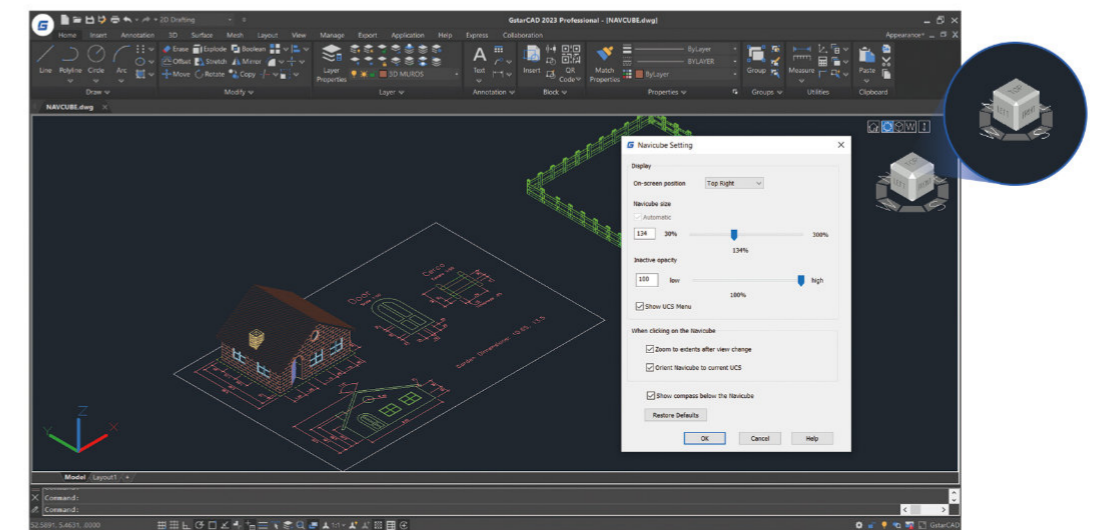

Lisp Debugger

You can execute the VLISP command to launch the Visual Studio Code as the Lisp Debugger in GstarCAD 2023. The GstarLisp extension adds support for Lisp files to Visual Studio Code, which allows you to edit and debug your lisp programs with GstarCAD conveniently.

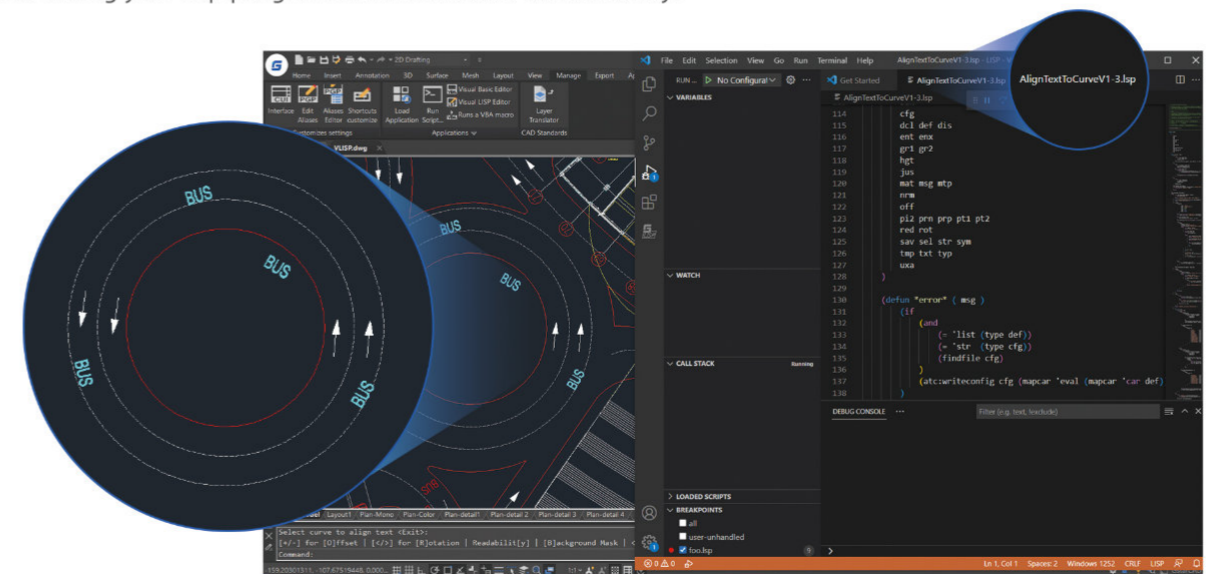

Digital Signature

Two digital signature features are provided to offer reliable information, and validate the authenticity and integrity of drawings.

DIGITALSIGN

The DIGITALSIGN command attaches a digital signature to a drawing, which can provide reliable information of the origin, identity and status on a drawing file.

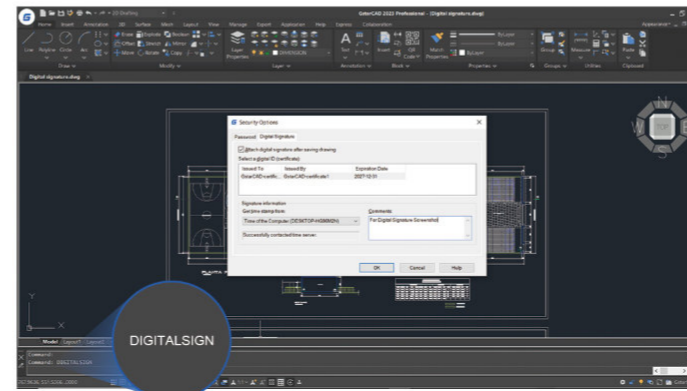

SIGVALIDATE

The SIGVALIDATE command validates the digital signature attached to a drawing file. The Validate Digital Signatures dialog box that shows information about the digital signature is displayed. If an unauthorized change is made or the signed file is corrupted, the digital signature becomes invalid.

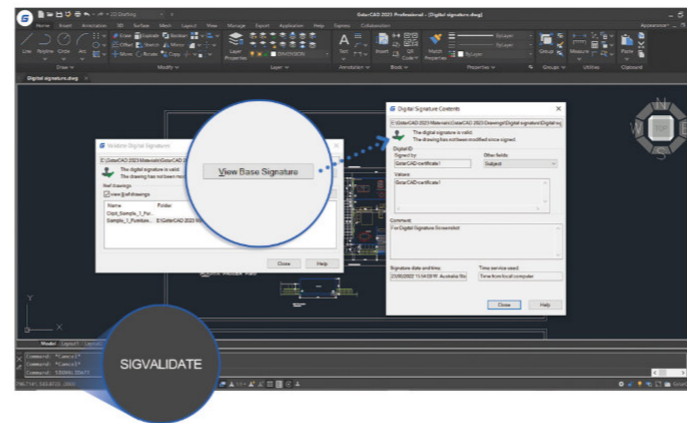

VPSYNC

With the VPSYNC command, you can synchronize one or more layout viewports to a master layout viewport to have the exact locations matched up. All synchronized viewports use the zoom factor of the master viewport. It's essential for printing super-long drawings separately or matching up maps precisely.

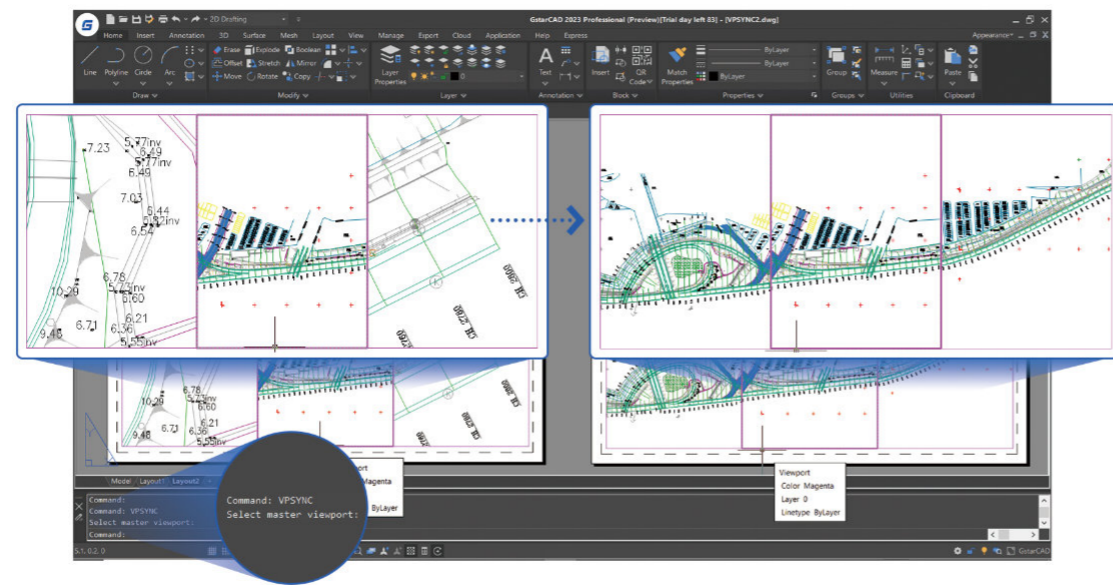

SYSVARMONITOR

The SYSVARMONITOR command monitors a list of system variables and sends notifications when any one of them changes. There are some system variables already in the monitor by default, which you can add or remove in the "Edit System Variable List" dialog box.

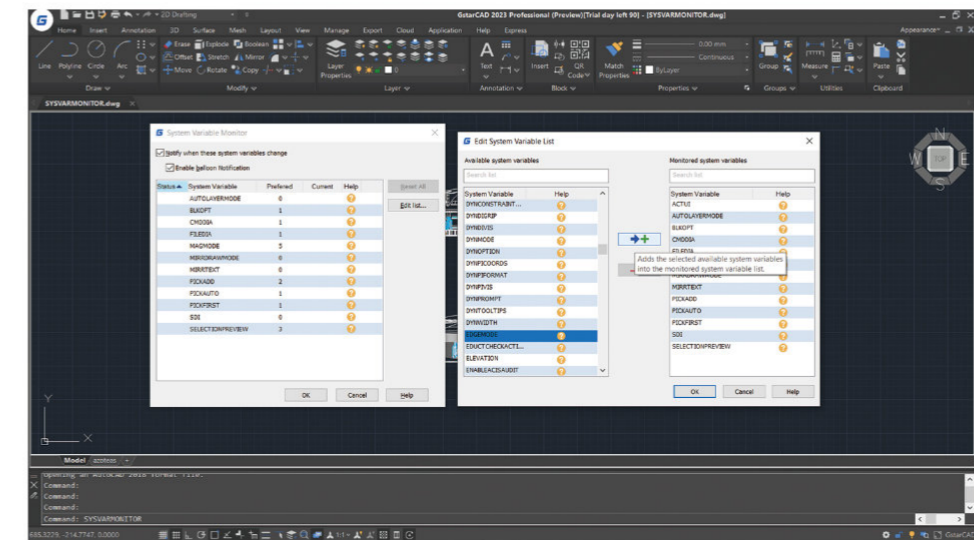

Reset Settings to Default

The Reset Settings to Default option in Windows Start menu helps reset GstarCAD settings to default much quicker and more easily than doing it manually. You can also choose to back up and reset custom settings.

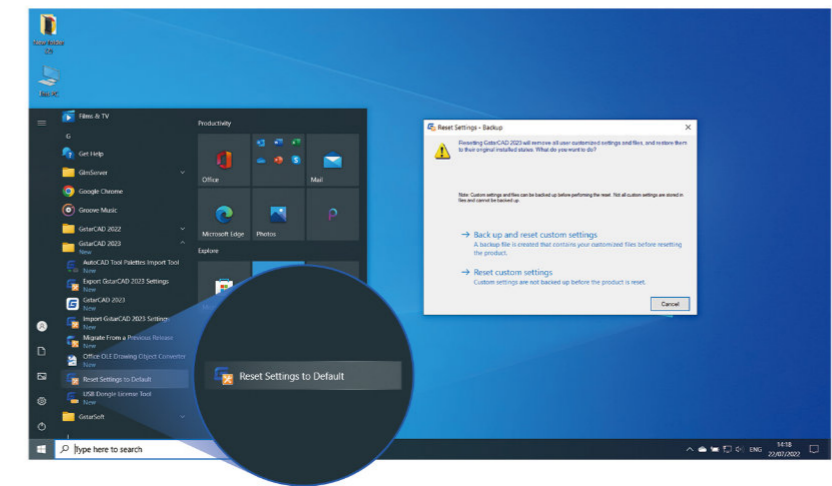

LAYOUTMERGE

The LAYOUTMERGE command merges specific layouts into a single layout. All layouts or model are available to be picked, and you can specify an existing layout or enter a new name to create a new layout as the destination layout.

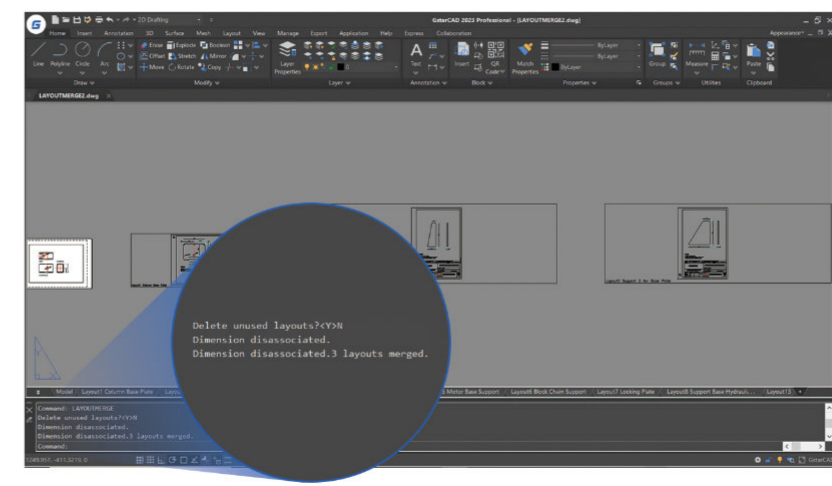

CLIPIT

The CLIPIT feature clips or removes specified portions of blocks, Xref drawings, images, and wipeout objects by defining polyline, circle, arc, ellipse, text, mtext, or attribute definition as clipping boundaries. And you can set the maximum allowable error distance for resolution of arc segments.

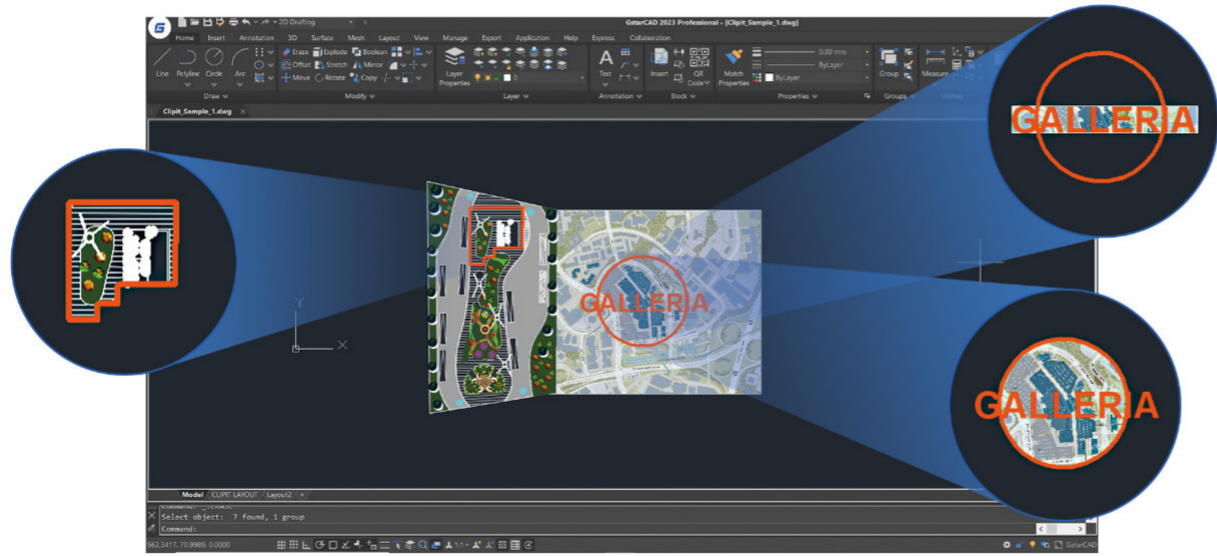

CLOSELINE

If it prompts that the area is not closed when hatching, calculating areas, or creating regions, the CLOSELINE command can mark unclosed endpoints among selected lines, polylines or arcs, and close them immediately.

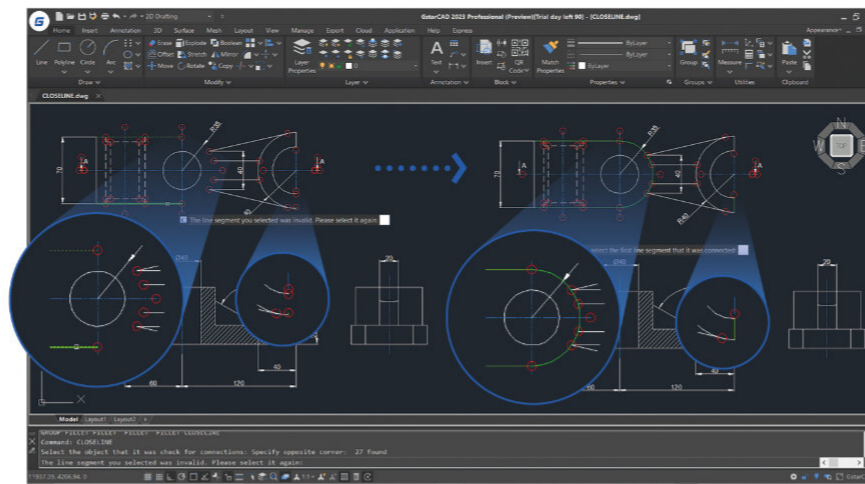

ATTIPEDIT

The ATTIPEDIT command provides a quick and easy way to edit the textual contents of an attribute of a block when you feel like editing the attribute values without accessing the attribute editor.

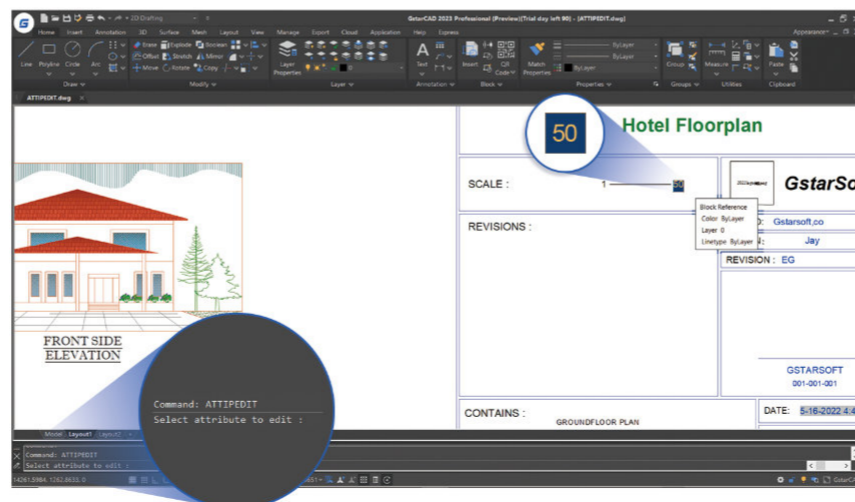

Innovative

SVG File

In GstarCAD 2023, SVG (Scalable Vector Graphics) files are available to be imported and exported.

Import

The imported SVG graphic is a block, which can be edited directly after being exploded or be edited in the Block Editor. Objects like lines, polylines, polygons, circles, ellipses, path, text and hatch can be imported correctly.

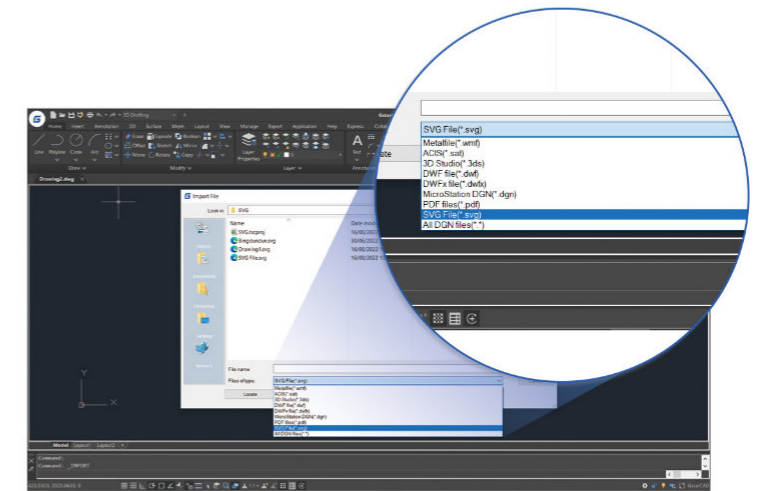

Export

Almost all kinds of objects in a drawing can be exported as a SVG file. And the exported SVG file can be displayed accurately in third-party tools.

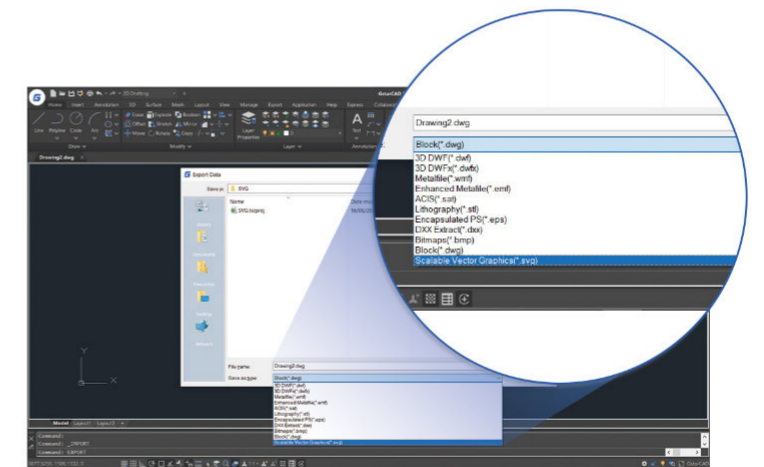

SIEMENS



Canon Japan



HONDA



NOKIA

PHILIPS

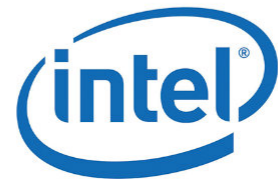

GSTARCAD MALAYSIA
www.gstarcad.com.my

Gstarsoft Co.,Ltd



5/F Unit C, Building 201, No. A10,
Jiuxianqiao North Road,
Chaoyang District, Beijing, 100015, PR China



+86 10 57910629



+86 10 57910609 ext.



sales@gstarcad.net www.gstarcad.net